

**RO-C, RO-M, RO-M EW, RO-XL,
RO-EDW, RO-EDW GEOspread**



RotaFlow RO Series Disc Spreaders



Every Crop Deserves the Best Care

Vicon Crop Care believes that technology makes a better future. We develop intelligent solutions for a better harvest and to increase crop yields, because every crop deserves the best care. Our smart solutions help the farmers work in an easier and more profitable way.

Kverneland Group is a leading international company developing, producing and distributing agricultural machinery and services, with a long history based on a clear vision: listen to the farmers and make their work easier.

Today Kverneland Group, part of Kubota Corporation from Japan, has production sites in Norway, Denmark, Germany, France, The Netherlands, Italy, Russia and China. The company has Sales Companies in 17 countries and exports to another 60 countries worldwide.



**Spreaders for farmers
who spread their crops in
an accurate and durable way.**

For modern farmers optimal spreading of fertiliser means using the exact amount of nutrition and avoiding overlap. Vicon fertiliser spreaders guarantee accurate spreading, are easy to operate and provide many years of trouble free usage.

For the farmer: higher yields, lower costs and less waste.

The RotaFlow Principle

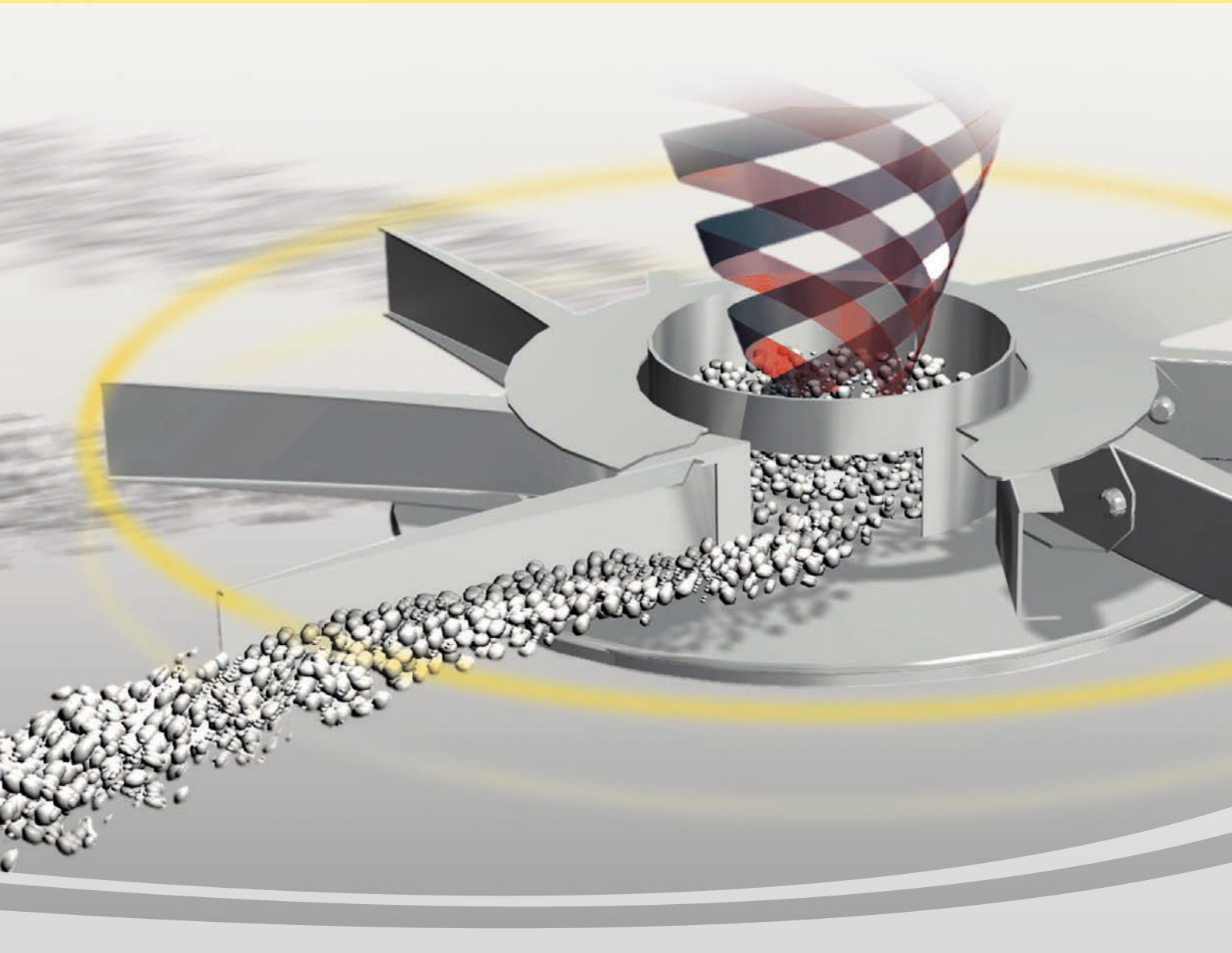

1. No impact, no fragmentation, no dust

Central release point, smooth acceleration and centrifugal force accelerates fertiliser up to disc speed before it reaches the vane.

2. Accurate spread pattern

Large 8 vane discs allow 9m to 54m spread widths. Double overlap spread pattern gives unrivalled accuracy. The 8 vanes per disc are ensuring a continuous flow of fertiliser to the field. This is important for high capacity spreading and forward speed.

3. Minimal wind influence, maximum tolerance

Flat discs. Horizontal spread pattern.

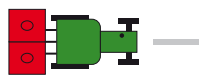
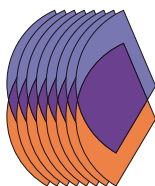

8 vanes per disc

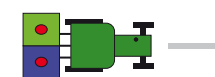
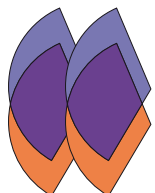

2 vanes per disc

4. Consistent spread pattern

Double overlap spread pattern.



Up to 24m working widths



From 24m working widths

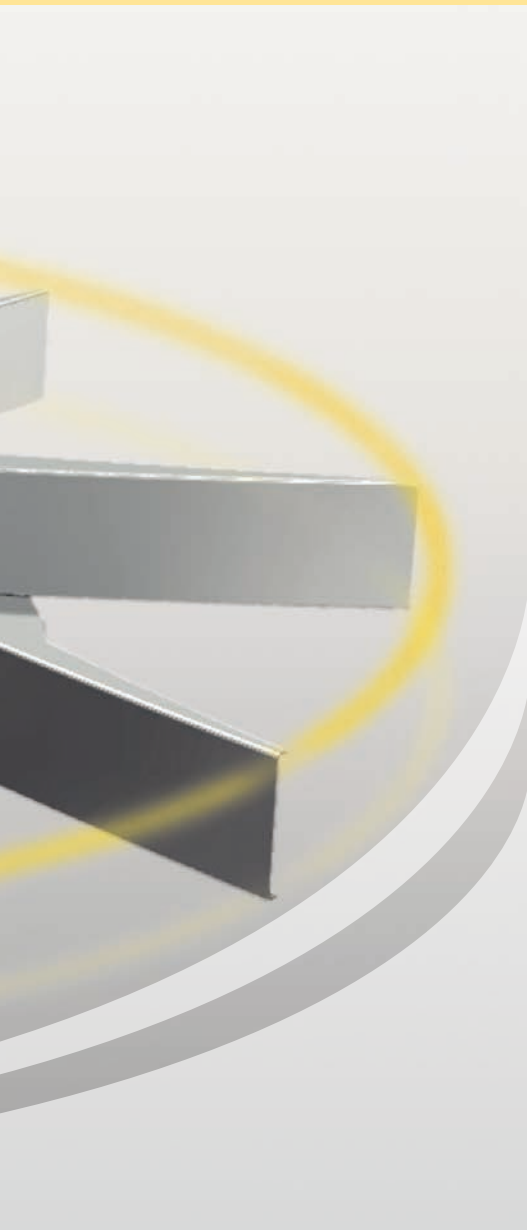

The name RotaFlow describes the Vicon spreading system; the fertiliser granules are already rotating when they reach the spreading vanes.

This initial smooth acceleration of the fertiliser prevents fragmentation of the granules due to the impact of the vanes. The adjustable discharge point allows adaptation of settings of the physical fertiliser properties. Due to the gentle handling of the fertiliser the spreading characteristics of the product are maintained. The RotaFlow spreading system is designed for the optimal spreading result!



Fine application rate

Discharge point

Application rate



FlowPilot:

easy setting and adjustment

The compact FlowPilot 'dashboard' gives you considerably simplified accurate setting and adjustment of application rates. Two hydraulically operated metering plates, each with three discharge openings ensure an equal fertiliser flow from the hopper to the spreading discs.

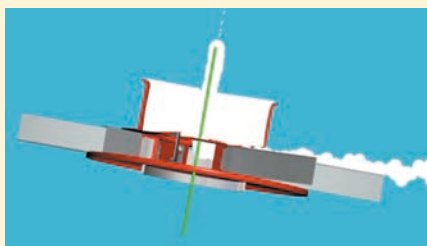

RotaFlow

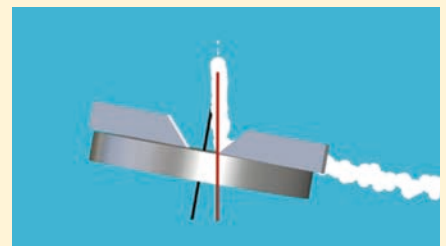

Competitive spreaders

5. Guaranteed accuracy on slopes

The fertiliser always contacts the vanes at the same point, also on slopes, and travels the complete length of the vane.

Competitive spreaders:

Poor fertiliser distribution on slopes is caused by the continuously changing the contact point on the vanes.

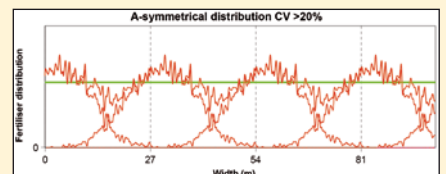
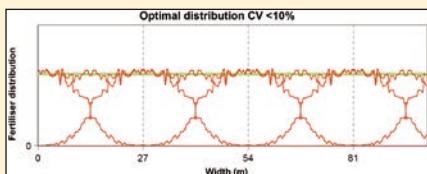
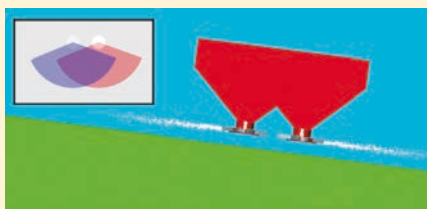

RotaFlow RO-EDW GEOspread®

GPS Controlled Intelligent Machine Solutions



Spreading has never been so easy and accurate! The RO-EDW GEOspread is a weighing spreader with integrated section control to provide optimal use of nutrients to your crops. The weighing system continuously checks and controls the desired application rate, regardless of forward speed or fertiliser flow characteristics. The GEOspread system makes it possible to adjust the working width and application rate individually for both discs, simply and accurately directly from the tractor cab, just by touching the ISOBUS terminal! The spreader is equipped with two electrical actuators mounted on each dosing unit. One of the actuators controls the setting of the discharge point, for placing the fertiliser onto the disc (letter setting), the other controls the application rate.

When running in conjunction with IsoMatch GEOcontrol you can operate the RO-EDW GEOspread even more easily. Based on previous coverage, field borders and headlands the automatic section control adjusts the working width and dosing system to suit overlaps and coverage using a GPS positioning system. For example, when driving in a wedge or irregular shaped field, GEOspread will start to decrease the working width step by step. GEOspread is using the Section Control (SC) function of the IsoMatch Tellus with GEOcontrol software or any other ISOBUS Universal Terminal (UT) with section control functionality.

The spreader working width is divided into sections, similar to the sections of a sprayer, with a minimum section width of only 2 metres. By keeping a constant disc RPM and accurately adjusting the discharge point, GEOspread allows you to switch off section by section, from one side to the other, until the last outer section in for example a wedged headland! Even in such cases the CV (coefficient of variation) of the total spreading pattern remains optimised.

Of course not only the spreading width is adjusted, at the same time the application rate (kg/min) is adjusted automatically to match the revised spreading width. This unique combination of working width and application rate adjustment makes the GEOspread system extremely accurate, with minimum influence on the spread pattern.

The advantages:

- Quick and accurate section control, due to the actuators being directly connected to the discharge point.
- Stable disc RPM in combination with discharge point adjustment maintains the spreading pattern (coefficient of variation).
- The small 2 metre sections (max. 24 sections) can be switched inside-out and outside-in to keep overlaps to the minimum.
- Easy operation; no need to step off the tractor to adjust the working width.
- 100% ISOBUS compatible for easy operation.



IsoMatch GEOcontrol additional software application within the IsoMatch Tellus Terminal.

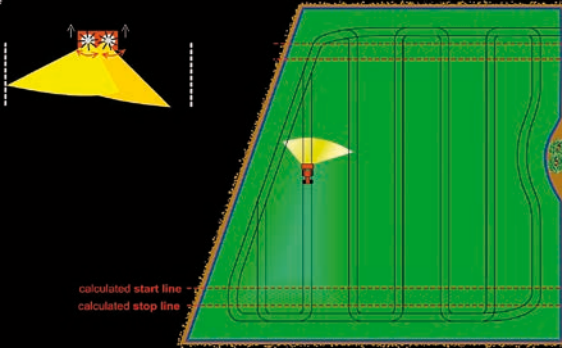

Accurate spreading in irregular shaped fields



Two actuators on each dosing unit to control the discharge point and application rate



Full spreading width of 54m with 24 sections



Decreasing the spreading width on the right hand side by 6m



Decreasing the spreading width on the left hand side by 10m



Decreasing the spreading width on both sides by 8m



Switching off the sections outwards



Switching the sections over the middle from one side

RotaFlow RO-M EW, RO-EDW and RO-EDW GEOspread®

High Tech Weighing!



RotaFlow RO-M EW (Easy Weigh)

Hopper capacity 1.100-2.000 litres
Working width 10-24 (27/28) metres

Standard features include:

- All vanes for 10-24 metres (27/28 optional)
- Fine application kit
- 2 delta shaped heavy duty grids
- Overload clutch
- Stainless steel hose connections
- Grading box to test fertiliser quality

RotaFlow RO-EDW / RO-EDW GEOspread

Hopper capacity 1.500-3.900 litres
Working width 12-45 (54) metres

Standard features include:

- LED lighting set
- Fine application kit
- 2 high capacity and robust sieves
- Overload clutch
- Low speed agitator
- Stainless steel hose connections
- Grading box to test fertiliser quality



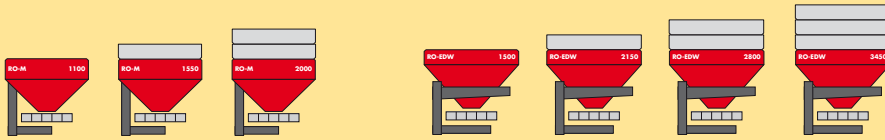

RO-M EW and RO-EDW / RO-EDW GEOspread: providing the unique advantages which only Vicon can give you!

1. Load cells in combination with the unique reference sensor

- Auto calibrating and continuous weighing system
- Automatic correction on slopes
- Automatic correction of shocks, even on rough terrain
- Automatic speed related dosing system
- No calibration test needed

2. RotaFlow spreading system

- Smooth acceleration: no fragmentation of the fertiliser granules, no dust
- Horizontal throw: minimises wind influence
- Precise overlap: in hilly and flat conditions

3. Operator comfort

- ISOBUS compatible as standard
- Operator terminal with intuitive menu and “Plug & Play” principle
- Forget time consuming calibration processes
- Simple setting and adjustment with the FlowPilot ‘dashboard’
- Automatic start/stop with GPS on head lands possible

Continuous dynamic “online – calibration” with high frequency communication signal.

Vicons unique reference sensor technology: all negative influences are automatically corrected and eliminated, ensuring utmost spreading accuracy even on hillsides. The Vicon reference sensor gives you absolute accuracy, because every kilo counts!

The advantages:

Highest accuracy in all conditions: even spreading quality guaranteed! Save costs and increase quality: spreading the Easy Weigh!

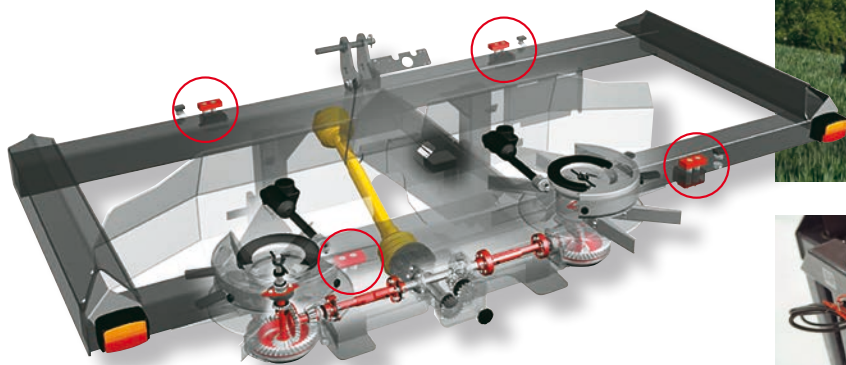

4 x 5 tonne weigh-cells (RO-EDW / RO-EDW GEOspread)



1 x 10 tonne weigh-cell (RO-M EW)

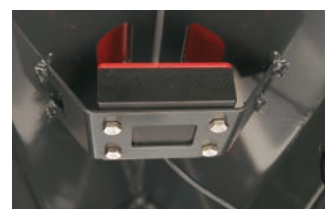

1 x Reference sensor, unique to Vicon

RotaFlow RO-XL

Large Working Widths, Bigger Volumes



RotaFlow RO-XL

Hopper capacity 1.500-3.900 litres
Working width 12-45 (54) metres

XL for Extra Large

The RO-XL is the high capacity spreader of the RotaFlow range. The maximum load capacity with 3 extension rims is 3.450 or 3.900 litres, depending of the hopper width. The working width is set using the tractor PTO speed and dual input shafts on the spreader centre gear box. An innovative driveline to each disc ensures gentle agitation due to the "slow rotating" agitator system, which runs at 15% of the spreading disc speed.



Easy working width adjustment

Convenient setting of the working width and a triangular spreading pattern. Above 24 metres working width, the angle indicator assists in tilting the machine 4 or 8 degrees. Both discs can be shut off independently to spread half the working width, essential for preventing lodging in tapering headlands.

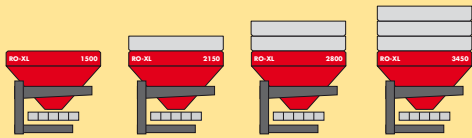

RO-XL 2150 lt



Calibration container (option)



Low speed agitator

Standard features include:

- Fine application kit
- 2 high capacity and robust sieves
- LED lighting set
- Overload clutch
- Low speed agitator
- Stainless steel hose connections
- Grading box to test fertiliser quality



Long life time LED lighting set



Central hydraulic drive
(for RO-XL/RO-EDW/RO-EDW GEOspread)



To spread bigger working widths a set of lift vanes is available (option for RO-XL/RO-EDW)

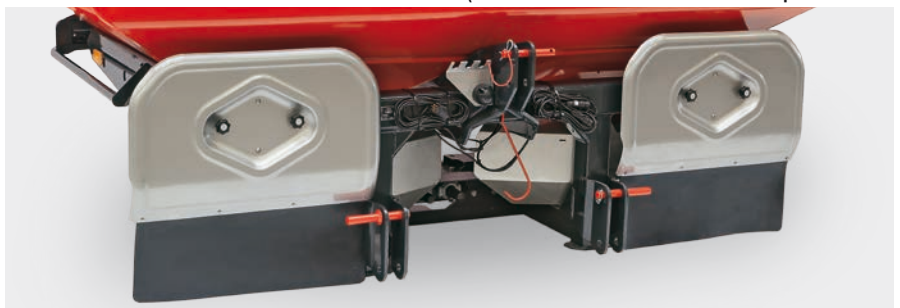

Mudguards
(option for RO-XL/RO-EDW/RO-EDW GEOspread)

RotaFlow RO-M

Master in the Medium Segment



To ensure a consistent flow when spreading low quantities, the RotaFlow system is equipped with a fine application kit. Ideal for spreading low quantities, seeds and slug pellets.

RotaFlow RO-M

Hopper capacity	1.100-2.000 litres
Working width	10-24 (27/28) metres

Each spreading disc has 8 vanes and their length determines the working width of the machine. These 8 vanes contribute to the highly accurate spread pattern across the complete working widths reaching from 10 up to 28 metres. Both discs can be shut off independently to spread half the working width, essential for preventing lodging in tapering headlands.

Standard features include:

- All vanes for 10-24 metres (27/28m optional)
- Fine application kit
- 2 delta shaped heavy duty grids
- Overload clutch
- Stainless steel hose connections
- Grading box to test fertiliser quality



Stainless steel hose connections

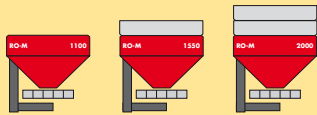

RO-M 1550 lt



Delta shaped heavy duty grids



Grid locked in open position



Agitator



Easy to assemble extension rims

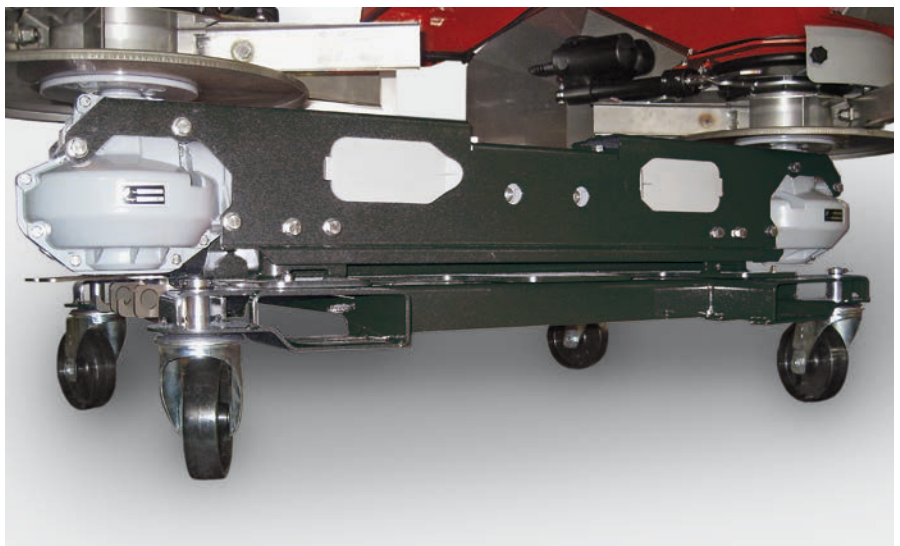

Parking frame with wheels (not for RO-C)

RotaFlow RO-C

Compact and Complete

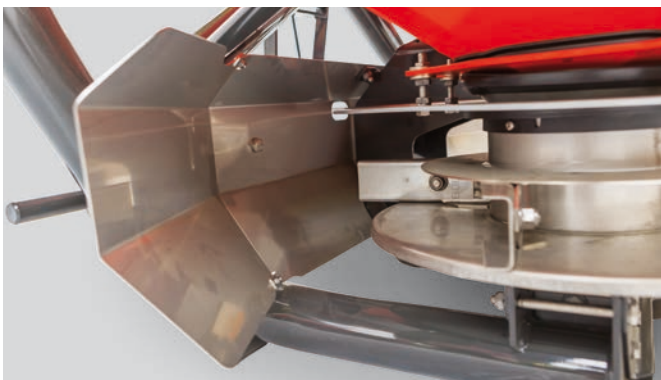

4 detachable vanes per disc determine the working width



Quick and convenient rate setting

RotaFlow RO-C

Hopper capacity 700-1.400 litres
Working width 9-18 (20/21) metres

The RO-C is controlled either manually or hydraulically. It is the most compact spreader in the range, but features all elements of the RotaFlow spreader line.



C for Compact

The working width is determined by the vane length. The 4 vanes can be detached easily, also for a static calibration test. Application rate adjustment from the calibration position is easily accessible.



RO-C 900 lt

Standard features include:

- All vanes for 9-18 metres (20/21m optional)
- Overload clutch
- Stainless steel hose connections
- Robust steel sieves
- Right hand spreading disc can be shut off
- Grading box to test fertiliser quality

Optional:

- Fine application kit
- LED lighting set



LED lighting set (optional for RO-C, RO-M and RO-M EW)



Select Your Control System

IsoMatch GEOcontrol: Brings Clear Benefits



IsoMatch Tellus - The New Generation Terminal

The IsoMatch Tellus is the first Universal Terminal with the capability to view and operate 2 different ISOBUS interfaces at once. This allows direct control of 2 implements at the same time, use GEOcontrol or display a camera view, without switching screens.



- Two ISOBUS interface screens
- Large 12.1" colour touch screen
- Intuitive operation
- Basic DOC registration program to save operational information directly to USB
- Four USB slots for easy data exchange (e.g. ISO-XML field maps, PDF), wireless USB stick or USB to serial cable for additional sensors
- Built in PDF reader: store and read any PDF document such as operator manuals
- RS232 connection for GPS receivers or sensors
- Internet connection via a wireless USB stick or router
- Integrated web browser

The IsoMatch is your powerful platform for precision farming applications and future growth.

Specially sealed actuators to cope with corrosive conditions



IsoMatch GEOcontrol

IsoMatch GEOcontrol is an additional software application within the IsoMatch Tellus and IsoMatch Tellus GO helps you to control all ISOBUS compatible Kverneland Group machines such as sprayers, spreaders and seeders! Combined with a GPS receiver it fulfils the future needs in terms of easy, smart and efficient farming.

Section control

Automatic switching on and off implement sections on headlands, boundaries and already covered areas to minimise overlap.

Variable rate control

Automatically adjusts the implement application rate based on input from the field prescription or crop sensors.

Documentation

Saves all operational job data and field maps for exchange via USB to farm management information systems.

Manual guidance

- Advised driving position using guidance lines (straight, curved or combined) in the field and on headlands
- Extendable using the optional IsoMatch InLine light bar, to place guidance in line of sight
- Headland control: create headland boundary and headland guidance lines
- Smart boundary recording: independent from the working width, even without any implement corrected
- Boundary shrinking: create new inner boundaries by setting the desired width of the headland
- Manual guidance for all operations, includes non-electric or non-ISOBUS implements. e.g. cultivators, mowers, tedders etc.



ISOMATCH GEOcontrol

- Easy and comfort of operation, due to not having to manually switch on or off sections or change the application rate. You can focus 100% on the driving in the field.
- More efficient work and avoiding overlap leads to cost savings of 5-10% on e.g. fertiliser, pesticides and seed. Better growing conditions and the increased yield.
- With IsoMatch GEOcontrol, working at night time becomes very easy.

IsoMatch GEOcontrol reduces the workload considerably.

IsoMatch Tellus GO

The IsoMatch Tellus GO is a Universal ISOBUS Terminal. This multifunctional one-screen terminal has been developed for fast and simple control of any ISOBUS implement, giving the farmer a 'custom made' experience as it suits all needs for simple and efficient handling of farming machinery and tasks.



- Multifunctional one-screen Terminal with 7" touch screen
- Fast and simple implement control via touch screen, rotary button and hard keys or additional joystick
- Display of all relevant machine status information like speed, working width and application rate
- Application includes Manual Guidance, coverage logs and documentation of task data like: working time, machine specific total: i.e. total hectares, kg's of fertiliser, litres of spray liquid, number of bales, etc. and additional details such as farm, operator, field, machine, etc.
- Support for external variable rate systems
- 2x USB 2.0 connections
- Camera input
- Diagnostic and service info

Additional functionality via the GEOcontrol application:

- IsoMatch GEO-SC: Automatic Section Control
- IsoMatch GEO-VR: Automatic Variable Rate via prescription maps

Comfort Control II



With Comfort Control II for our RO-M and RO-XL, you can operate the spreader from the closed tractor cab. The operating panel provides all the functions to start and stop the spreader, to set the right application rate and to increase and decrease the application rate on the move. The latest settings are retained in the memory function. Both discs can be shut off independently to spread half working width.

iM FARMING

smart efficient easy **FARMING**



iM FARMING makes mechanical work smarter, more efficient and simpler. The use of ISOBUS technology makes machines easier to connect, operate, control and monitor.

Maximum return from your investments, that is the core of Kverneland Group's iM FARMING solutions. iM FARMING describes and presents our offering on ISOBUS machines and solutions for electronic steering of implements. All aimed at giving an insight into the benefits and efficiency of our extensive offering, adapted to your requirements. That is what you can expect from Kverneland Group. Now and in the future. Intended to make life easier for farmers. follower of these new technologies!

► Intelligent Spreading – Prepared for The Future

Smart and modern technology prevents waste of expensive fertiliser and ensures perfect alignment on the headlands and in the triangles. Overlap is a thing of the past, which not only saves on fertilisers and crop protection agents, it also ensures a more equal crop yield and quality. Each plant receives exactly the same amount of crop protection; iM FARMING precision solutions make it as easy as possible.

► Precision Spreading with GEOspread

How clever would you like to be? Why spread fertiliser to the left when you have already been there? That's why we have developed GEOspread. It allows you to operate field sections with up to 2m accuracy (max. 24 sections). A 36m working width is divided into eighteen sections, each two metres wide. It is up to you to decide how to work, from the centre outwards, or from left to right.

Once you have set the working width and dosage per hectare, the spreader automatically adjusts its output as it goes. In addition, the spreader can operate on the basis of spreading charts or crop sensors; where more fertiliser is required, the spreader spreads more and where the optimum has been reached it will reduce its output. The eventual objective is a maximum crop of consistent quality.

- 100% ISOBUS compatible
- No overlap on headlands
- Parcel registration and data storage
- Up to 15% saving on fertiliser
- Automatic switching ON/OFF through IsoMatch GEOcontrol





IsoMatch GEOcontrol and SPREADERcontrol

Do you want to save 5% to 10% of your spreading costs (fuel and fertiliser)? Do you want to control and optimise your spreading process by working at night without worries and to be at the forefront of environmental constraints?

This is all possible with the Vicon RO-EDW GEOspread spreader from Kverneland Group!



RO-M EW



RO-EDW, RO-EDW GEOspread



IsoMatch InLine



Manual guidance



Section control



Variable rate control



Documentation



AutosetApp

► IsoMatch GEOcontrol

Once your spreader is equipped with an IsoMatch Tellus you can simply unlock the IsoMatch GEOcontrol application and you get access to all modules of precision agriculture: section control, variable rate control, manual guidance, AutosetApp and boundary shrinking and documentation tasks to transfer info to your PC. To get familiar with and convince yourself of the IsoMatch GEOcontrol application you are entitled to 25 free hours of use before purchasing the license. No doubt for us, you will quickly become a passionate follower of these new technologies!

► GEOspread - Intelligent Farming

The GEOspread system provides maximal accuracy in spreading. Thanks to the electric actuators, the discharge point can be changed automatically to vary the spreading width by sections of 2m. This means the working width can be adjusted very quickly and accurate by just touching the ISOBUS terminal!



IsoMatch Global



IsoMatch Eye



GEOspread



GEOspread



The RotaFlow 6 Star Checklist for Accurate Spreading



The key to accurate spreading is matching fertiliser quality and litre weight with the spreading charts as close as possible. The RotaFlow 6 star checklist helps you to ensure consistent accuracy in all field conditions.

- 1 Select fertiliser type
- 2 Determine granule size and distribution*
- 3 Determine litre weight

- 4 Select spreading table
- 5 Select field settings
- 6 Adjust RotaFlow FlowPilot

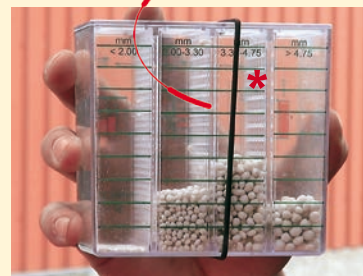

* A fertiliser grading box is provided as standard with all Vicon RotaFlow spreaders

Granule size	Kg/l	Shape	Fertilizer	Manufacturer
80-20-00-00	0.74	Pilled	Urea 46% N	Yara 15
67-33-00-00	1.08	Granular	Perika Standard	Degussa AG 20
15-85-00-00	1.04	Crystalline	Granular 2	DSM 25
10-90-00-00	0.75	Pilled	Urea 46% N	Polonia 31
10-90-00-00	1.00	Crystalline	Schwefelsaures Ammoniak (21% SO3)	DOMO Cap 36
00-100-00-00	1.00	Pilled	Nitrapill 34.5% N	GrowHow 43
05-80-14-00	0.98	Blead	Sulphur Gold (30%N + 19%SO2)	GrowHow 51
00-80-20-00	1.05	Pilled	NPK 20-7-10	Yara 52
00-75-24-01	1.00	Blead	Kayeme (NP 26-15)	GrowHow 60
03-69-28-00	1.03	Crystalline	D...	DOMO Cap 61

Field settings		Border spreading	
Spreader inclination	0°	PTO revolutions	Eco Yield
PTO revolutions	570	Disc revolutions	476 570
Disc revolutions	750	Disc revolutions	625 750
Fine application kit	No	TrimFlow position	EA SA



Discharge point



Access by mobile phone via:
<http://vicontab.mobi>
 or download the spreading charts Application from the App Store or Google Play Store.



Exact advise for each Vicon spreader at any working width, application rate and driving speed.
 Direct access to most recent test results at:
www.viconspreadingcharts.com



Calibration rate

AutosetApp: The most up to date settings for your weighing spreader are always available!

The AutosetApp is an App (software application) available on the IsoMatch Tellus terminal. The AutosetApp is standard integrated into the IsoMatch Tellus GEOcontrol software. This App connects the IsoMatch Tellus terminal directly with the Vicon RO-EDW GEOspread weighing spreader and will automatically adjust the spreader according to the settings entered into the App. The AutosetApp will also work in combination with the RO-M EW and RO-EDW, with the exception being for those spreaders the discharge point (letter setting) still needs to be adjusted manually on the spreader itself.

The Vicon fertiliser spreader database with the most up to date spreading charts is always available online. The AutosetApp can connect to the fertiliser spreading database in two different ways. You can connect it to the online database via the IsoMatch Wireless WIFI USB adapter or download the most actual database from the internet website www.viconspreadingcharts.com on a USB stick and upload the database directly into the IsoMatch Tellus terminal.



Vicon Spreader Competence Centre



The Vicon disc spreaders are known worldwide for their reliability, ease of operation and outstanding accuracy in all conditions. This is the result of many years of practical experience, research and testing. A fertiliser spreader can only be set accurately for rate and overlap using the settings provided by the manufacturer. The Spreader Competence Centre is using the most modern technology available in hard and software, allowing the measurement of complete overlap patterns in 3D. Instead of only measuring the spreading pattern in one line corresponding to the working width, this new technology creates a full pattern showing a complete 3D spreading profile of the fertiliser.

The 3D spread pattern is achieved using a spreader which is mounted on the test rig which rotates the machine through 280°. Continuous measurement at a frequency of 5 HZ over the 80 collecting trays, which are all individually equipped with weigh cells, provide the ultimate in testing accuracy. A single test run provides more than 30 000 measurements! The result is a very precise spread pattern analysis with a high degree of predictability for setting changes to suit different widths and application rates.

This allows, faster testing of the various types of fertiliser, but at the same time results in using less fertiliser and improved quality for better protection of our environment. The 60m long test hall, with under-floor heating, maintains the humidity at 60% which allows testing throughout the year; and can accommodate testing of spreading working widths above 54 metres.

In the Spreader Competence Centre we are also measuring the GEOpoint (B distance) of the spreader. The 3D spreading pattern of the spreader produces a cone shape, depending of the fertiliser type and settings. For optimum performance when opening and closing the spreader dosing system on headlands, the gravity point or centre of the spreading pattern, of this cone is used. This GEOpoint setting is entered in the IsoMatch GEOcontrol application on the IsoMatch Tellus to optimise the spreading pattern on headlands, preventing under and over dosing. The benefits of the GEOpoint are cost savings and improved crop quality on headlands.

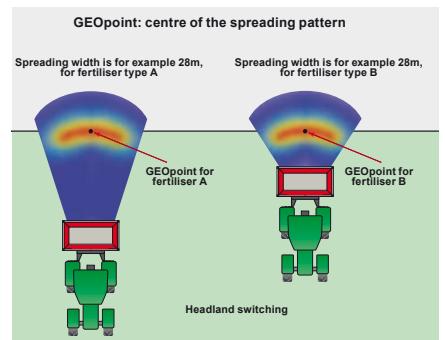

Border Spreading Systems



Border Spreading Plate



Hydraulic border spreading plate (not for RO-C)



Border spreading using the border spreading plate (available as manual or hydraulic version)

Tramline Cylinder



Optional for RO-C and RO-M only



Border spreading from the tramline

TrimFlow

The RO-M, RO-M EW, RO-XL, RO-EDW and RO-EDW GEOspread are also available with the TrimFlow border spreading system (for left and right hand side).

The TrimFlow can be accurately set for all types of fertiliser and for all working widths. Operation is easy, no need to leave the tractor seat.

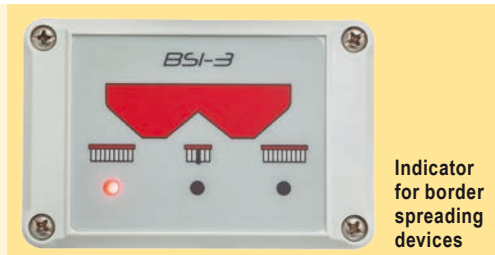

Indicator for border spreading devices



TrimFlow border spreading system (not for RO-C)



Border spreading using the TrimFlow system

Technical Specifications

RO-C	RO-C 700	RO-C 900	RO-C 1400	
Hopper capacity (l)	700	900	1400	
Filling height (cm)	96	108	128	
Width (cm)	154	154	176	
Filling width (cm)	148	148	170	
Empty weight (kg)	250	270	290	
Spread width (m)	9-18 (20/21)*	9-18 (20/21)*	9-18 (20/21)*	
Output (kg/min)	10-230	10-230	10-230	
RO-M	RO-M 1100	RO-M 1550	RO-M 2000	
Hopper capacity (l)	1100	1550	2000	
Filling height (cm)	100	119	138	
Width (cm)	220	220	220	
Filling width (cm)	214	214	214	
Empty weight (kg)	325	350	375	
Spread width (m)	10-24 (27/28)*	10-24 (27/28)*	10-24 (27/28)*	
Output (kg/min)	10-320	10-320	10-320	
RO-M EW	RO-M EW 1100	RO-M EW 1550	RO-M EW 2000	
Hopper capacity (l)	1100	1550	2000	
Filling height (cm)	100	119	138	
Width (cm)	220	220	220	
Filling width (cm)	214	214	214	
Empty weight (kg)	380	400	425	
Spread width (m)	10-24 (27/28)*	10-24 (27/28)*	10-24 (27/28)*	
Output (kg/min)	10-320	10-320	10-320	
RO-XL (narrow)	RO-XL 1500	RO-XL 2150	RO-XL 2800	RO-XL 3450
Hopper capacity (l)	1500	2150	2800	3450
Filling height (cm)	110	129	148	167
Width (cm)	275	275	275	275
Filling width (cm)	269	269	269	269
Empty weight (kg)	495	525	555	585
Spread width (m)	12-54*	12-54*	12-54*	12-54*
Output (kg/min)	10-320	10-320	10-320	10-320
RO-XL (wide)	RO-XL 1875	RO-XL 2550	RO-XL 3225	RO-XL 3900
Hopper capacity (l)	1875	2550	3225	3900
Filling height (cm)	120	139	158	177
Width (cm)	290	290	290	290
Filling width (cm)	284	284	284	284
Empty weight (kg)	530	565	595	625
Spread width (m)	12-54*	12-54*	12-54*	12-54*
Output (kg/min)	10-320	10-320	10-320	10-320
RO-EDW / RO-EDW GEOspread (narrow)	RO-EDW / RO-EDW GEOspread 1500	RO-EDW / RO-EDW GEOspread 2150	RO-EDW / RO-EDW GEOspread 2800	RO-EDW / RO-EDW GEOspread 3450
Hopper capacity (l)	1500	2150	2800	3450
Filling height (cm)	110	129	148	167
Width (cm)	275	275	275	275
Filling width (cm)	269	269	269	269
Empty weight (kg)	665	695	725	755
Spread width (m)	12-54*	12-54*	12-54*	12-54*
Output (kg/min)	10-320	10-320	10-320	10-320
RO-EDW / RO-EDW GEOspread (wide)	RO-EDW / RO-EDW GEOspread 1875	RO-EDW / RO-EDW GEOspread 2550	RO-EDW / RO-EDW GEOspread 3225	RO-EDW / RO-EDW GEOspread 3900
Hopper capacity (l)	1875	2550	3225	3900
Filling height (cm)	120	139	158	177
Width (cm)	290	290	290	290
Filling width (cm)	284	284	284	284
Empty weight (kg)	705	735	765	795
Spread width (m)	12-54*	12-54*	12-54*	12-54*
Output (kg/min)	10-320	10-320	10-320	10-320

* Depending on fertiliser type and type of vanes.

Information provided in this brochure is made for general information purposes only and for worldwide circulation. Inaccuracies, errors or omissions may occur and the information may thus not constitute basis for any legal claim against Kverneland Group. Availability of models, specifications and optional equipment may differ from country to country. Please consult your local dealer. Kverneland Group reserves the right at any time to make changes to the design or specifications shown or described, to add or remove features, without any notice or obligations. Safety devices may have been removed from the machines for illustration purposes only, in order to better present functions of the machines. To avoid risk of injury, safety devices must never be removed. If removal of safety devices is necessary, e.g. for maintenance purposes, please contact proper assistance or supervision of a technical assistant.

© Kverneland Group Nieuw-Vennep BV



Kverneland Group

Kverneland Group is a leading international company developing, producing and distributing agricultural machinery and services.

Strong focus on innovation allows us to provide a unique and broad product range with high quality. Kverneland Group offers an extensive package aimed at the professional farming community, covering the areas of soil preparation, seeding, forage and bale equipment, spreading, spraying and electronic solutions for agricultural tractors and machinery.



Original Spare Parts

Kverneland Group spare parts are designed to give reliable, safe and optimal machinery performance - whilst ensuring a low cost life-cycle. High quality standards are achieved by using innovative production methods and patented processes in all our production sites.

Kverneland Group has a very professional network of partners to support you with service, technical knowledge and genuine parts. To assist our partners, we provide high quality spare parts and an efficient spare parts distribution worldwide.

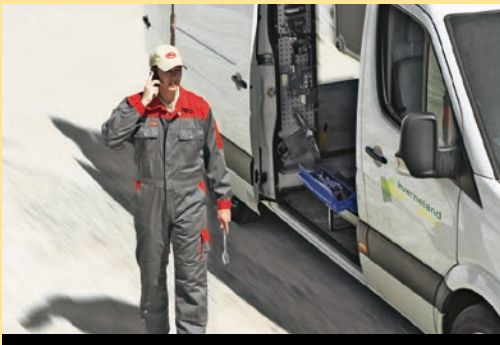

Watch us on YouTube
www.youtube.com/kvernelandgrp



Like us on facebook
www.facebook.com/KvernelandGroup
www.facebook.com/iMFarming



Follow us on Twitter
[#KvernelandGroup](https://twitter.com/KvernelandGroup)
[#iM_Farming](https://twitter.com/iM_Farming)

Kverneland Group UK Ltd.
 Walkers Lane, Lea Green, St. Helens
 Merseyside, WA9 4AF
 Phone + 44 1744 8532 00

Kverneland Group
 N-4355 Kverneland
 Norway
 Phone: + 47 51 42 94 00
contact@kvernelandgroup.com